

User Manual

Color video door phone CDV-70U



- Thank you for purchasing COMMAX products.
- Please carefully read this User's Guide (in particular, precautions for safety) before using a product and follow instructions to use a product exactly.
- The company is not responsible for any safety accidents caused by abnormal operation of the product.

Greetings









- Thank you for choosing COMMAX.
- Please read this manual carefully before you use the product.

Table of contents













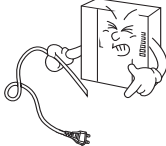



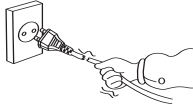





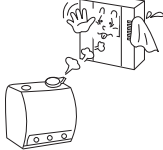

Greetings	1
Contents table	1
1. Warnings and caution	2
2. Product Overview	4
3. Operation Methods	5
4. Settings	6
5. Installation	8
6. Wiring	9
7. Part lists	11
8. Caution in use	12
9. Miscellaneous	12
10. Specification	12

1. Warnings and caution

Please follow the things described below in order to prevent any danger or property damage.

 <p>Warning It may cause a serious damage or injury if violated.</p>  <p>Caution It may cause a minor damage or injury if violated.</p>	<ul style="list-style-type: none">  Prohibition.  No disassembly  No touch  Must follow strictly.  Shows plugging out the power cord without an exception  Shows the warning and caution for an electric shock.  Shows the warning and caution for a fire.
---	--

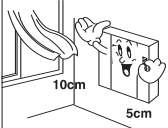
Warning

Power & Installation	<p>Please don't use several products at the same time on one power socket. · It may cause a fire due to an abnormal overheating.</p>  <p> </p> <p>Prohibition Fire</p>	<p>Please don't bend the power cable excessively or it may cause an electric shock. · fire when using a damaged power cable.</p>  <p>  </p> <p>Prohibition Electric shock Fire</p>	<p>Please don't handle the power cable with a wet hand. · It may cause an electric shock.</p>  <p> </p> <p>Prohibition Fire</p>	<p>Please plug out the power cable from the socket when not using it for a long period of time. · It may shorten the product lifespan or cause a fire.</p>  <p> </p> <p>Request Fire</p>
	<p>Please don't install the product in the place where there is much oil, smoke or humidity. · It may cause an electric shock or fire.</p>  <p>  </p> <p>Prohibition Electric shock Fire</p>	<p>Please don't install the product with the lightning and thunder. · It may cause an electric shock or fire.</p>  <p>  </p> <p>Prohibition Electric shock Fire</p>	<p>Please don't use and connect this product with other products with different rated voltage · It may cause a disorder or fire.</p>  <p> </p> <p>Prohibition Fire</p>	<p>When installing the product that generates heat, please install the product away from the wall (10cm) for the ventilation. · It may cause a fire due to the increased internal temperature.</p>  <p> </p> <p>Prohibition Fire</p>

Warning

Cleaning & Use

Please don't disassemble, repair or rebuild this product arbitrarily (please contact the service center if a repair is needed).

- It may cause an electric shock or fire.



If an abnormal sound, burning smell or smoke is coming out of the product, please plug out the power cable and contact a service center.

- It may cause an electric shock or fire.

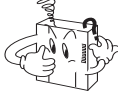

Please don't insert any metallic or burnable materials into the ventilation hole.

- It may cause an electric shock or fire.

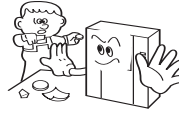

Please use only the designated batteries for the products of using DC power.

- It may cause an electric shock or fire.



Caution

Power & Installation

Please plug the power cable firmly into the inner end

- It may cause a fire.

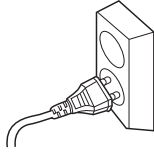

Please hold the plug tightly when unplugging the power cable (a part of the copper wire may be disconnected if the grabbing is only made on the cord when pulling out the cable).

- It may cause an electric shock or fire



When connecting the power cables after cutting the cable, please install the product with power off

- It may cause an electric shock or fire



When installing the product, please fix it firmly while using the wall-mounting unit and screws.

- It may cause an injury from the falling object.

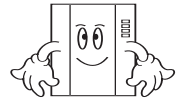

Please be careful when using an AC circuit breaker since there is a possibility of an electric shock.

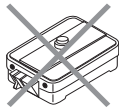

Please check the use voltage and current for the DC-only products and use the appropriate rectifier.

- It may cause a fire.



Please avoid direct rays of the sun or heating devices at a time of installation.

- It may cause a fire.

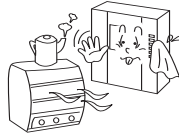

Please don't install the product on an unstable place or small support board.

- It may cause an injury if it falls down while in use.



Cleaning & Use

When cleaning the product, please rub it with a soft and dry cloth after plugging out the power cable. (Please don't use any chemical products such as wax, benzene, alcohol or cleanser.)



Please don't drop the product on the ground and don't apply a shock.

- It may cause a failure.

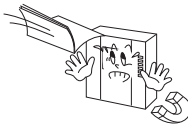

Please use the designated connection cable within the maximum calling distance designated for the product

- It may reduce the product performance.



2. Product Overview

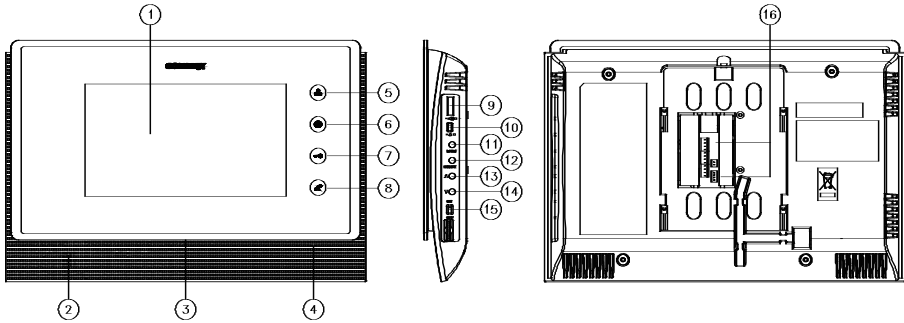

No.	Description	No.	Description
1	Monitor	9	Talk Sound Level Control
2	Speaker	10	Call Sound Level Control
3	On/Off & status LED	11	Menu Button
4	Microphone	12	Select Button
5	Monitor Button	13	Up Button (△)
6	Interphone Button	14	Down Button (▽)
7	Door Release Button	15	Power Switch
8	Talk Button	16	Connector Terminal

1. Monitor : You can check the visitor.
2. Speaker : You can hear the calling sound from the door camera.
3. On/Off & status LED :
Show blue light when the monitor is turned on, no light when off.
4. Microphone : You can talk with the visitor.
5. Monitor Button : Press to see images from camera.
6. interphone Button : Press to call interphone.
7. Door Release Button : Press to open the door.
8. Talk Button : Press to talk with door camera.
9. Receiver volume : to control the receiver volume.
10. Ringing volume : to control the ringing volume.
11. MENU Button :
Press to enter Menu for display adjustment, calling sound setting, product information etc.
12. Select Button : Press to select on menu.
13. Up Button : Press to move up on menu.
14. Down Button : Press to move down on menu.
15. Power Switch : Used to turn on/off power of the product.
16. Connector Terminal :
Used to connect other devices like door camera, door panel, or program update tool.



3. Operation Methods

3-1. Receiving a calling from visitor.

- ① When the call button is pressed by a visitor on the door camera, the melody shall be rung and visitors' image is shown on the screen
(If you do not press the Talk Button, the display will be shown up for 30 seconds and turned off automatically).
- ② By pressing the Call Button, you are able to talk with visitor. By pressing the Door Release Button, you can open the door for visitor(Open and close motion is working while talking over the interphone and it is limited to camera which has the function of open and close.)
- ③ In case of holding the handset of interphone during conversation, three-way conversation with the interphone will be done immediately.
(Camera-Monitor-Interphone talking at same time.)
- ④ If you press the Call button, the call will be ended and be in stand-by status.

3-2. Talk with Interphone.

(1) Calling from the Interphone.

- ① If you receive the call from the interphone, the ringing tone will sound.
- ② Press Call Button to talk with the interphone.
- ③ In case of calling from the entrance while conversation between interphone and household phone, the visitor's image will be shown and three-way conversation with household phone, interphone and camera will be done immediately.

(2) Calling the interphone from the monitor.

- ① Press the call button on the monitor, then press the interphone button to call the interphone. (Interphone button should be pressed & held until the interphone answers.)
- ② Then talking is available by picking up the handset of interphone.

3-3. Monitoring : To see the visitor at the door.

(On stand-by mode) Operation

- By pressing the Monitor button repeatedly, the monitor will work as following in order.
Camera 1 → Camera 2 → OFF → Camera 1 →

(On talking mode) Operation

- By pressing the Monitor button repeatedly, the monitor will work as following in order.
Camera 1 → Camera 2 → Camera 1 → Camera 2 →



4. Settings

On talking or monitoring mode, press menu button on the right side of product, and press Δ/∇ buttons to adjust display(brightness, contrast, color), to enter the Utility menu, to check the product information.

- Following 4 buttons on the right side of the product are used for setting.
- * Menu, End : MENU * Move up, right : Δ (UP Button)
- * Select, Input : SELECT * Move down, left : ∇ (DOWN Button)

4-1. Display Setting (Brightness, Contrast, Color Adjustment)

On Setting Mode, move to Door Video Set and press Select button to enter the display setting mode.

- (1) BRIGHTNESS : To adjust brightness.
- (2) CONTRAST : To adjust contrast.
- (3) COLOR : To adjust color.

※ How to adjust

- ① On DOOR VIDEO SET display press Δ/∇ to move to the item you want to adjust
- ② Press Select Button to select the item.
- ③ Adjust using Δ/∇ buttons.
- ④ Press Select Button again to finish.

- (4) RESET : Puts back settings to initial setting.

※ How to reset.

- ① On DOOR VIDEO SET display move to RESET item.
- ② Press SELECT Button to select the item.
- ③ Select YES using Δ/∇ buttons.
- ④ Press SELECT button to reset.

- (5) EXIT : Return to Configuration mode

4-2. UTILITY(Extra features)

- In video adjustment mode 5-1, move to UTILITY and press SELECT button.

- (1) LED DIMMING : Setting LED on the button for stand by mode. (Power LED function)

- ① Select No. 0 : the mode of all LED turned off

- ② Select No. 1 : Talk LED is repeated bright and dark mode
- ③ Select No. 2 : All LEDs are repeated bright and dark mode
- ④ Select No. 3 : All LEDs are repeated bright and dark mode by turns
- * Adjust LED dimming
 - ① Move to UTILITY and press SELECT button and Move to LED dimming menu with Δ/∇ button.
 - ② Press the SELECT button to enter the menu. (Adjusting level bar is shown)
 - ③ Adjust the values with Δ/∇ button.
 - ④ Press the SELECT button.
- (2) CHIME-BELL MUTE : Setting MUTE mode.
 - * Adjust CHIME-BELL MUTE
 - ① Move to UTILITY and press SELECT button and move to CHIME-BELL MUTE menu with Δ/∇ button.
 - ② Press the SELECT button to enter the menu. (Adjusting level bar is shown)
 - ③ Adjust CHIME-BELL MUTE with Δ/∇ button.
 - ④ Press the SELECT button.
- (3) SCREEN MODE : to select the proportion of image marked in the screen.
 - ① In the screen setting mode of 5-1, move to UTILITY icon and after pressing SELECT button, move to SCREEN MODE with Δ/∇ button.
 - ② Select the item by pressing SELECT button.
 - ③ Set the screen ratio with Δ/∇ button.
 - WIDE : full screen at the ratio of 16 to 9
 - 4:3 : real ratio(main entrance) of screen
 - ZOOM: expanded full screen at the ratio of 4 to 3
- (4) EXIT : Return to Configuration mode

4-3. INFORMATION (Model and Version checking)

Click Δ/∇ button to check the Model and version in configuration mode

- (1) Model : The name of Model
- (2) Version : The version of the product
- (3) VIDEO : The video type of the product
- (4) SOURCE : The location of the image

4-4. EXIT(End configuration)

Move to EXIT and click Select button.

5. Installation

1. Installation Method of camera monitor

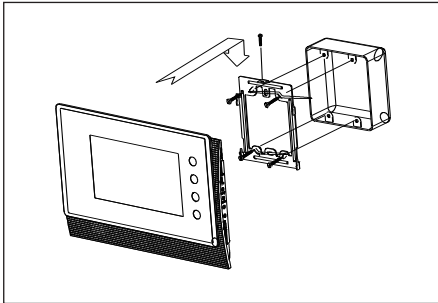

⚠ Note

- ① Avoid the range of direct sunlight
- ② Recommended height is pertinent from 1450 ~ 1500mm
- ③ Avoid the installation near magnetic activity, humid temperatures and gas

2. Installation Method of camera

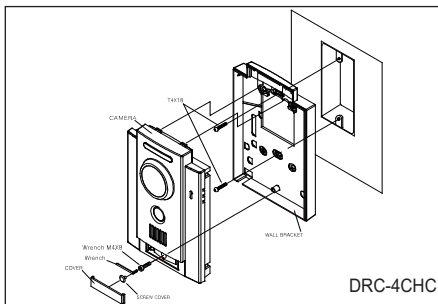

⚠ Note

- ① Do not install the camera where it is exposed to Direct sunlight
- ② Keep cleaning up its lens to capture good views.

6. Wiring

CAMERA CONNECTOR POLARITY

1. RED : VOICE 2. BLUE : GND 3. YELLOW : POWER(+12V) 4. WHITE : VIDEO

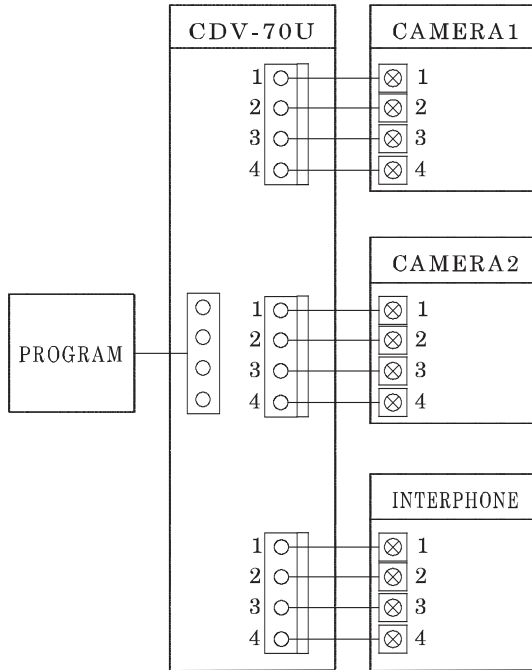

Caution on the Wiring

Be sure to use a separate wiring for each connect
2lines of UTP CABLE[CAT.5] are required if UTP CABLE[CAT.5] is used for
CAMERA1 and CAMERA2

DOOR Camera Wiring

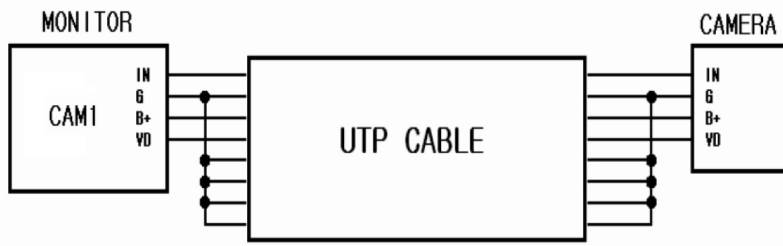

- If UTP CABLE[CAT.5] is used, use 5 lines for GND line.

INTERPHONE Wiring

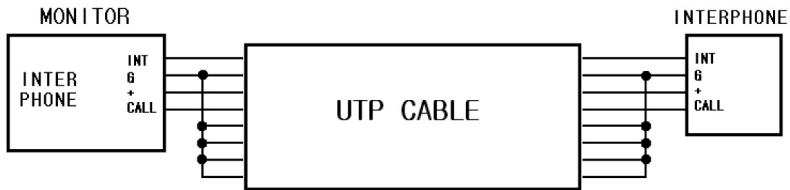

- If UTP CABLE[CAT.5] is used, use 5 lines for GND line.



7. Part list

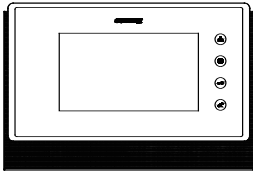

① Body of CDV-70U

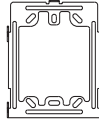

② Bracket for wall mount

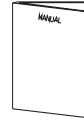

③ Manual

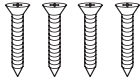

④ GH1T 4 X 18 ZnY
Screw for wall mount



⑤ PHM 3 X 6 ZnY
Screw for body

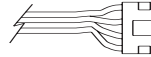

⑥ 4P(2EA)
Connector

① Monitor(CDV-70U)

② Wall bracket

③ Manual

④ Mounting Screw (SCREW GH1T 4X18 ZnY) – 4EA

⑤ Monitor fixing screw (SCREW PHM 3X6 ZnY) – 1EA

⑥ Connector (CONN. 4PX300) – 2EA



8. Caution in use

1. Turn on the power switch.
2. Please contact your local agent for product maintenance when you have a problem in use of CDV-70U
3. For your safety, power switch with a safety device must be used in your building.
4. Unplug before installing or repairing the product.
5. Unplug when you connect monitor with door cameras.



9. Miscellaneous

- Please carefully read this User's Guide before calling service man
After checking the entire check list, please contact customer service center.
We will do our best to make you satisfy with our services.



10. Specification

MODEL	CDV-70U		
Transmission way	Door camera 4wires (Polarity), interphone 4wires (polarity)		
Rating Voltage	100V-240V~, 50/60Hz (FREE VOLTAGE)		
Power consumption	On stand-by : 3.9W On talk : 16W		
Transmission way	HANDS FREE (Voice switch circuit)		
Monitor	7" TFT-DIGITAL LCD		
Call sound	Door : Electronic chime (Sol Mi Do), interphone : Beep		
Display	Monitoring : 30 ±5sec , Talk : 60 ±5sec		
Distance	Pie 0.5mm	0.65mm	0.8mm
	28m	50m	70m
Working temperature	0 ~+40°C (32°F ~ 104°F)		
Dimension	276(W) X 185(H) X 33(D)		

COMMAX

COMMAX Co.,Ltd.

513-11, Sangdaewon-dong, Jungwon-gu, Seongnam-si, Gyeonggi-do, Korea

Int'l Business Dept. Tel. : +82-31-7393-540~550 Fax. : +82-31-745-2133

Web site : www.commax.com

PM0270U00011

Printed In Korea / 2012.09.104